



CATALOG

Trailer Decal Installation Specification Sheets

February 27, 2026



TABLE OF CONTENTS

FRONT HEAD ALL TRAILER TYPES	3
ALUMINUM - BOTH SIDES	4
EXTERNAL RING - BOTH SIDES	5
STAINLESS - BOTH SIDES	6
REAR HEAD - EXTERNAL RING AND STAINLESS	7
REAR HEAD TRAILERS WITH REAR LADDER	8
REAR HEAD TRAILERS <u>WITHOUT</u> REAR LADDERS	9
ANTI-LOCK BRAKING SYSTEM (ABS) DECAL	10
2017-2025 FREIGHTLINER CASCADIA DAYCAB	11
2017-2025 FREIGHTLINER CASCADIA SLEEPER.....	12
2017-2025 MACK ANTHEM DAYCAB.....	13
2017-2025 MACK ANTHEM SLEEPER	14
ORDERING SERVICES.....	15
ORDERING SERVICES (Continued)	16

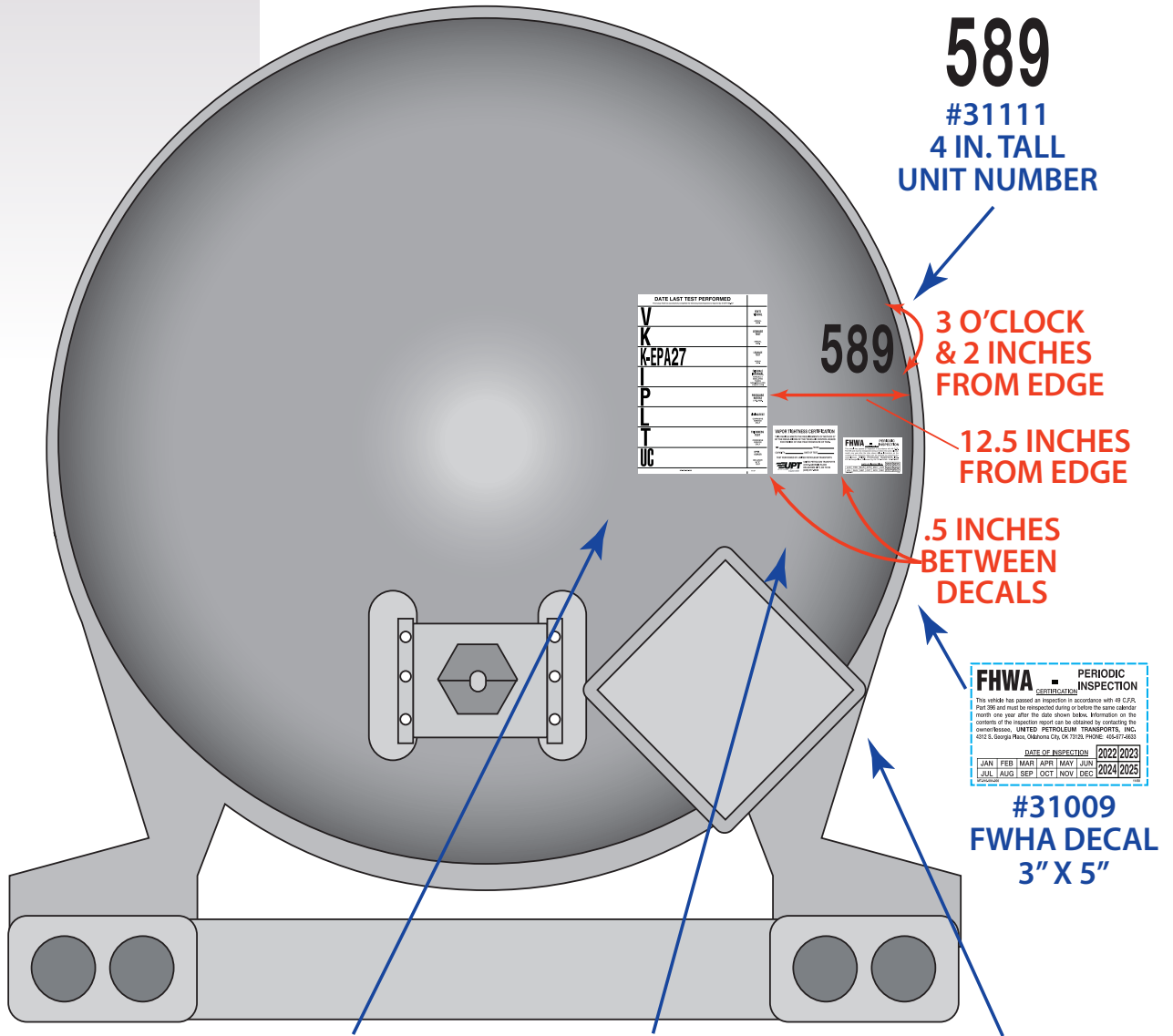

589
#31111
4 IN. TALL
UNIT NUMBER

589
3 O'CLOCK
& 2 INCHES
FROM EDGE

12.5 INCHES
FROM EDGE

.5 INCHES
BETWEEN
DECALS



#31009
FWHA DECAL
3" X 5"

NOT AT ANY SCALE

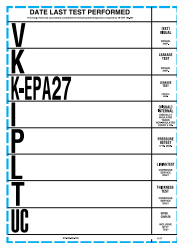

#31096
HM TEST LOG
15" X 11"

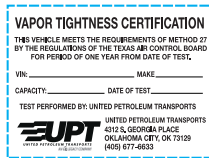

#31104
VAPOR TIGHTNESS
DECAL
4" X 5.5"



#31105
EMERGENCY
SHUT OFF DECAL
3" X 5"

UPT
UNITED PETROLEUM TRANSPORTS
#30778 UPT LOGO
72 INCH
20.5" X 71.94"
CENTER
HORIZONTALLY
ON CENTERLINE
OF BARREL.

NO SMOKING
#31095
NO SMOKING DEAL
5" X 17"

**#30925
TEN STEP DECAL
12" X 12"**
CENTERED ABOVE
LOADING HEADS
TOP EDGE
APPROXIMATELY
68 INCHES
FROM GROUND.

**DIESEL
FIRST**
#31097
DIESEL FIRST DECAL
5.6 25" X 5.625"

589
#31108
1.5 INCH TALL
UNIT NUMBER
MOUNTED ON VAPOR RAIL AT SAME
POSITION OF EACH COMPARTMENT
ENTRY HOLE ON TOP OF TRAILER.

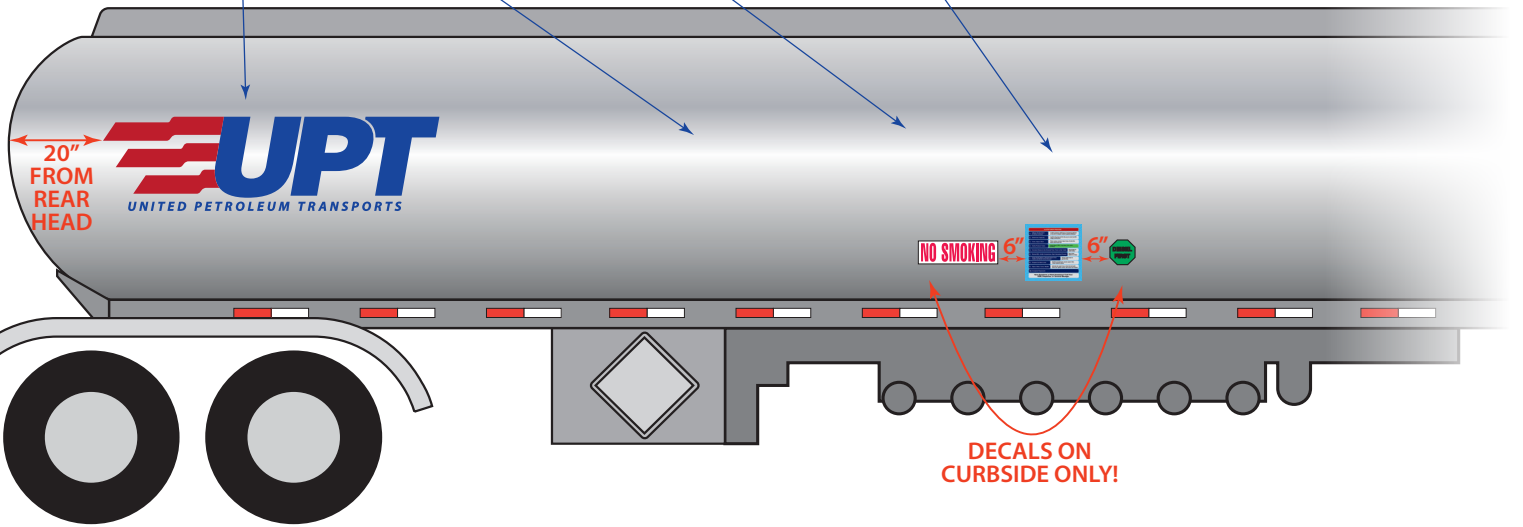

NOT AT ANY SCALE



#30781 UPT LOGO
 48 INCH
 13.73" X 48"
 FROM REAR HEAD,
 FIRST FULL SPACE DECAL FITS.
 CENTER HORIZONTALLY
 ON CENTERLINE OF BARREL.

NO SMOKING:
#31095
 NO SMOKING
 DECAL
 5" X 17"

#30925
 TEN STEP DECAL
 12" X 12"
 CENTERED ABOVE
 LOADING HEADS
 TOP EDGE APPROXIMATELY
 68 INCHES FROM GROUND.

#31097
 DIESEL FIRST
 DECAL
 5.6 25" X 5.625"

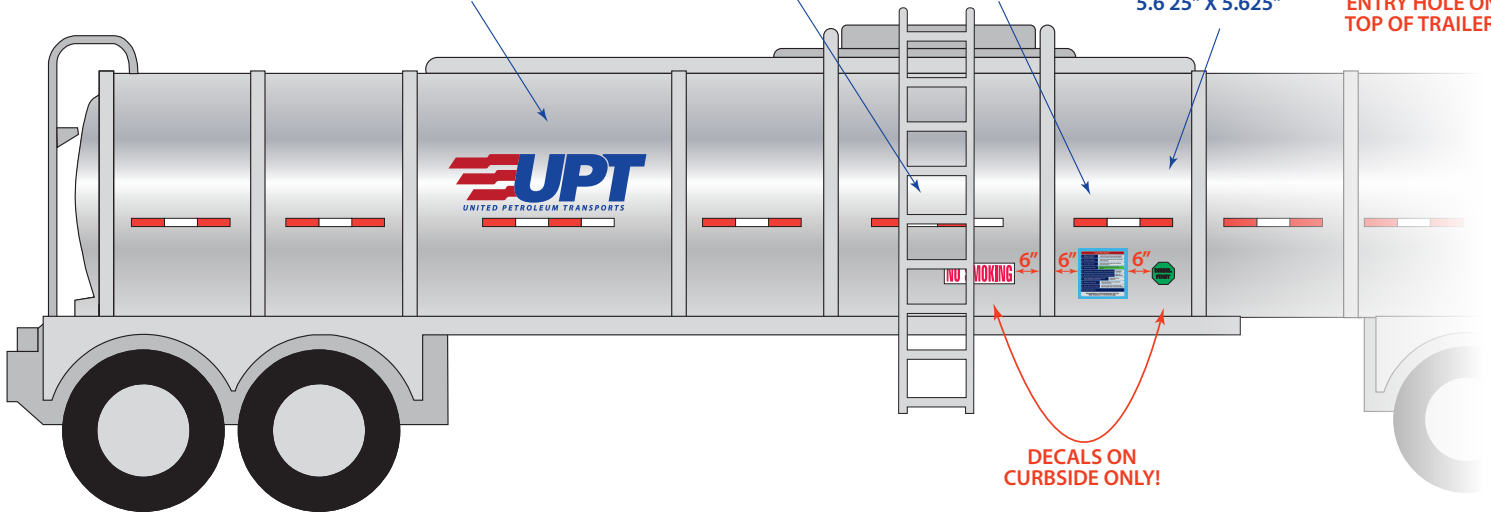
589
#31108
 1.5 INCH TALL
 UNIT NUMBER
 MOUNTED ON
 VAPOR RAIL AT SAME
 POSITION OF EACH
 COMPARTMENT
 ENTRY HOLE ON
 TOP OF TRAILER.



NOT AT ANY SCALE



STAINLESS - BOTH SIDES

UPT
UNITED PETROLEUM TRANSPORTS
#30778 UPT LOGO
72 INCH
20.5" X 71.94"
CENTER
HORIZONTALLY
ON CENTERLINE
OF BARREL.

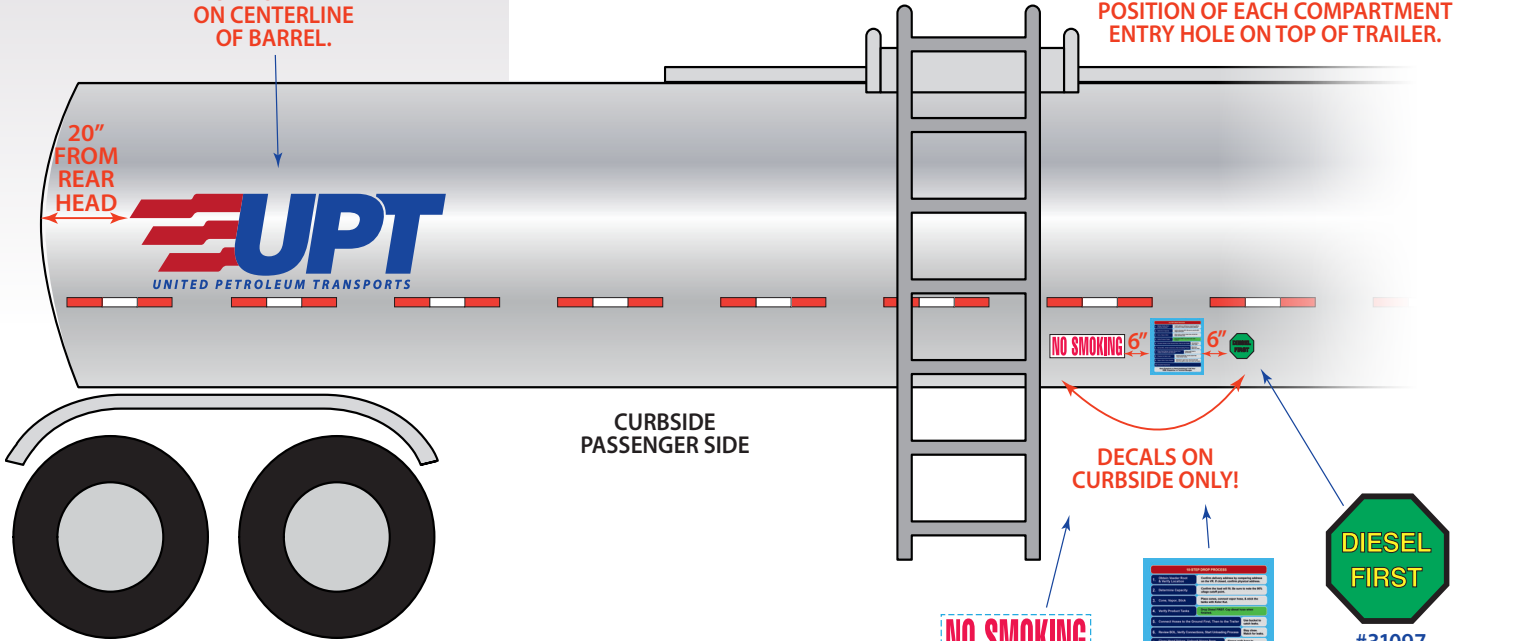

589
#31108
1.5 INCH TALL
UNIT NUMBER
MOUNTED ON VAPOR RAIL AT SAME
POSITION OF EACH COMPARTMENT
ENTRY HOLE ON TOP OF TRAILER.

CURBSIDE
PASSENGER SIDE

DECALS ON
CURBSIDE ONLY!

NO SMOKING
#31095
NO SMOKING DEAL
5" X 17"

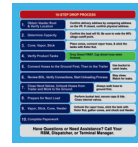

#30925
TEN STEP DECAL
12" X 12"



#31097
DIESEL FIRST DECAL
5.6 25" X 5.625"

CENTERED ABOVE LOADING HEADS
TOP EDGE APPROXIMATELY
68 INCHES FROM GROUND.

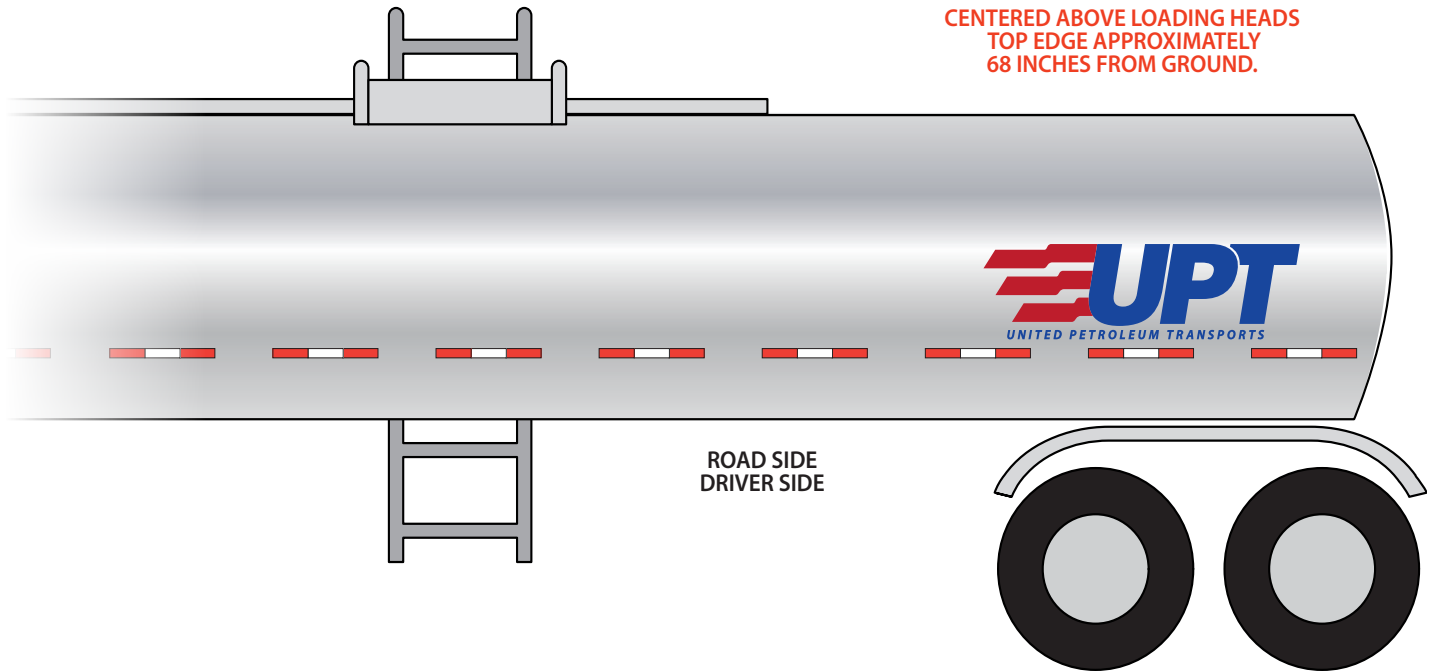

ROAD SIDE
DRIVER SIDE

NOT AT ANY SCALE



REAR HEAD - EXTERNAL RING AND STAINLESS



#30780
UPT LOGO- 36 IN.
10.5 IN. X 36 IN.

CENTER
36 INCH LOGO
AND SMALL
JOIN THE FAMILY

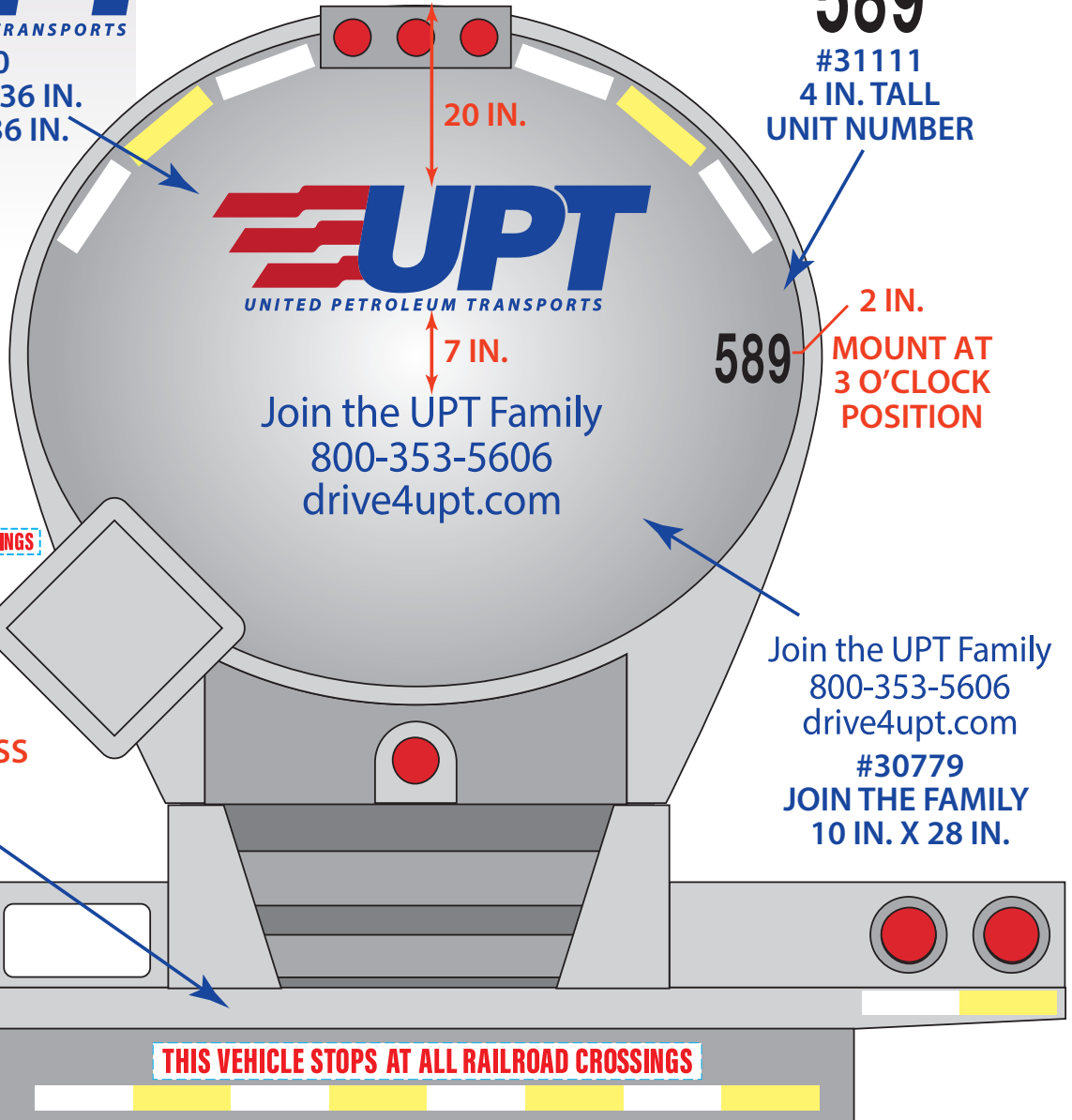

589

#31111
4 IN. TALL
UNIT NUMBER

20 IN.

7 IN.

589

2 IN.
MOUNT AT
3 O'CLOCK
POSITION

Join the UPT Family
800-353-5606
drive4upt.com

Join the UPT Family
800-353-5606
drive4upt.com
#30779
JOIN THE FAMILY
10 IN. X 28 IN.

THIS VEHICLE STOPS AT ALL RAILROAD CROSSINGS

#31109
RAILROAD
CROSSING
DECAL
3 IN. X 45 IN.
CENTERED ACROSS
REAR BUMPER

THIS VEHICLE STOPS AT ALL RAILROAD CROSSINGS

REAR HEAD TRAILERS WITH REAR LADDER



#30780
UPT LOGO- 36 IN.
10.5 IN. X 36 IN.

Join the UPT Family
800-353-5606
drive4upt.com

#30779
JOIN THE FAMILY
10 IN. X 28 IN.
CENTERED
UNDER LOGO

Join the UPT Family
800-353-5606
drive4upt.com

THIS VEHICLE STOPS AT ALL RAILROAD CROSSINGS

#31109
RAILROAD
CROSSING
DECAL
3 IN. X 45 IN.
CENTERED ACROSS
REAR BUMPER

THIS VEHICLE STOPS AT ALL RAILROAD CROSSINGS

597
#31111
4 IN. TALL
UNIT NUMBER

2 IN.
MOUNT AT
3 O'CLOCK
POSITION

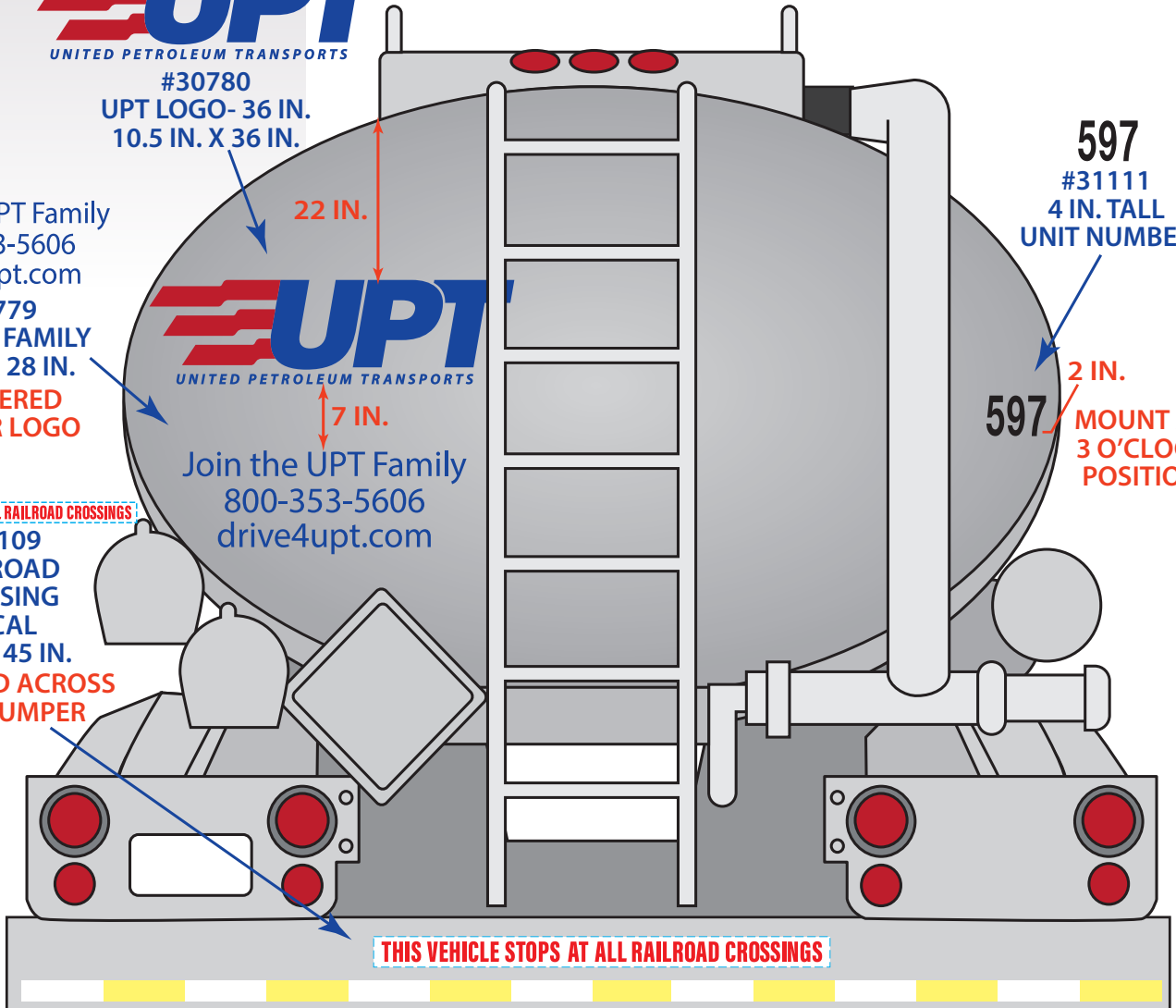



REAR HEAD TRAILERS WITHOUT REAR LADDERS

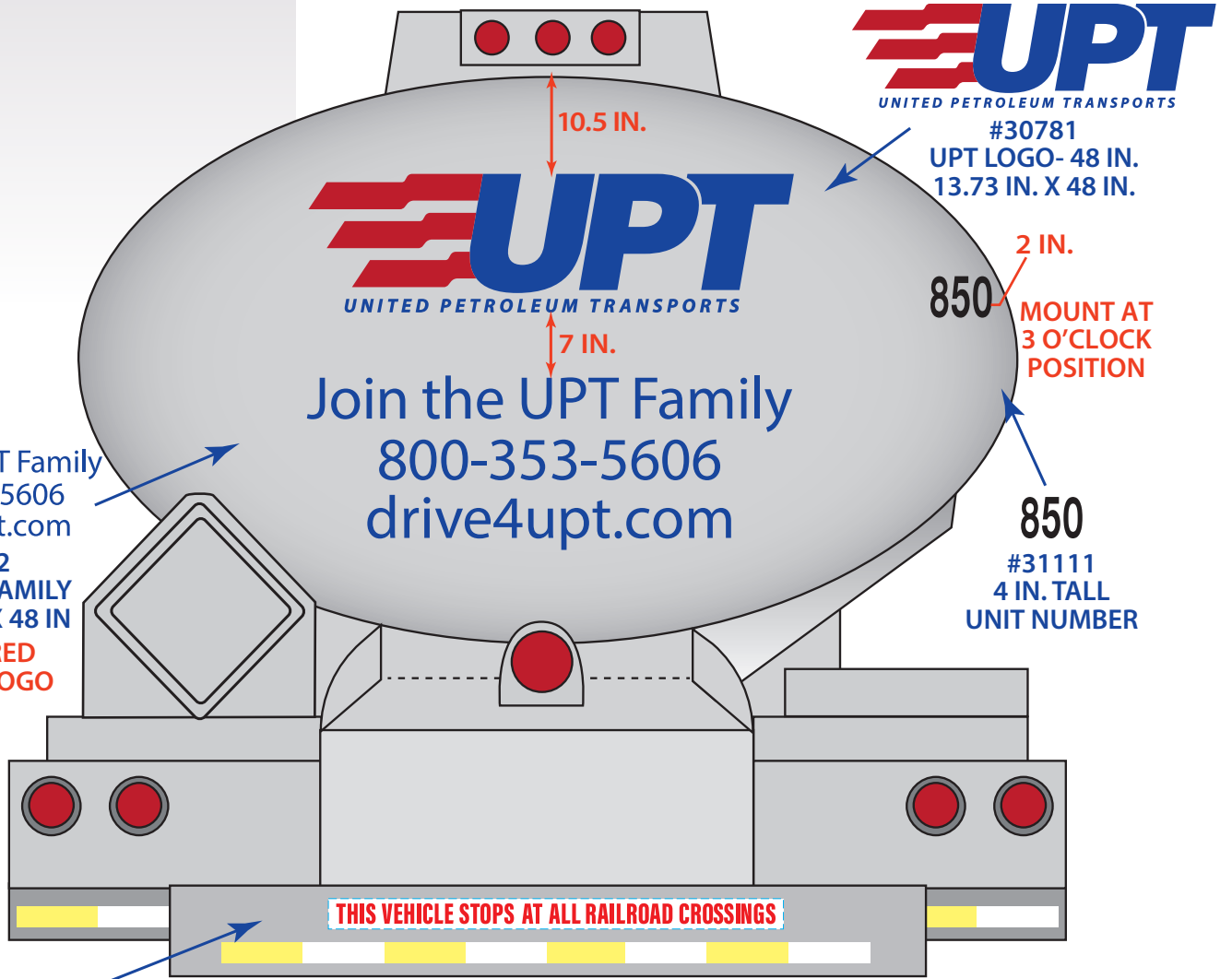

Join the UPT Family
800-353-5606
drive4upt.com
30782
JOIN THE FAMILY
17.25 IN. X 48 IN.
CENTERED
UNDER LOGO



#30781
UPT LOGO- 48 IN.
13.73 IN. X 48 IN.

2 IN.
MOUNT AT
3 O'CLOCK
POSITION

850
#31111
4 IN. TALL
UNIT NUMBER

THIS VEHICLE STOPS AT ALL RAILROAD CROSSINGS

#31109
RAILROAD CROSSING DECAL
3 IN. X 45 IN.
CENTERED ACROSS
REAR BUMPER



ANTI-LOCK BRAKING SYSTEM (ABS) DECAL

Mount on trailer body within 5 inches of the ABS lamp lens and housing.



**#32556
ABS DECAL
1.5 IN. X 3.5 IN.**

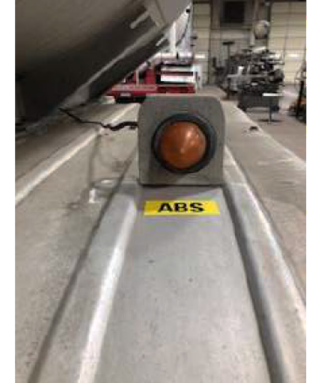

2017-2025 FREIGHTLINER CASCADIA DAYCAB

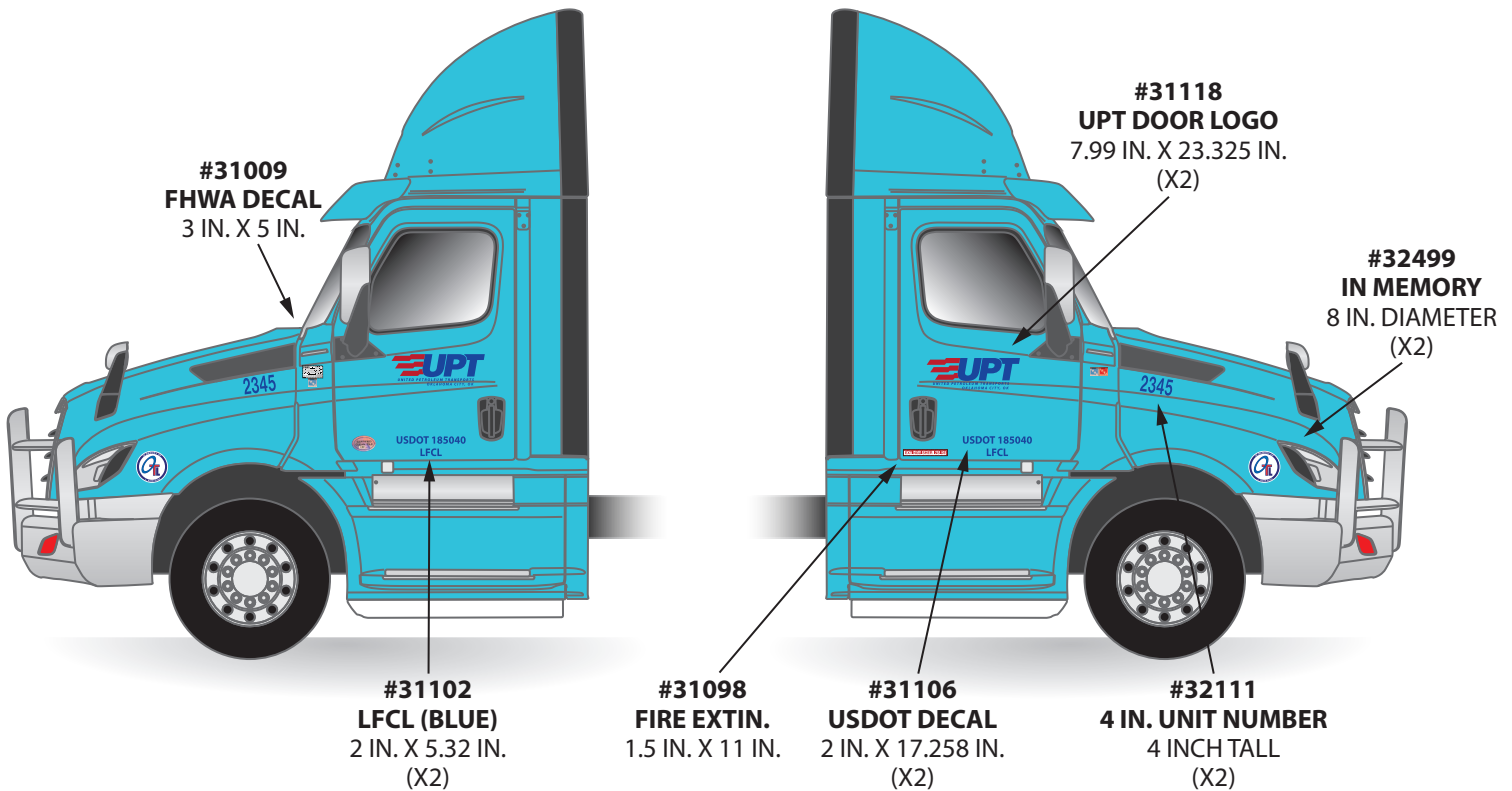

2017-2025 FREIGHTLINER CASCADIA SLEEPER

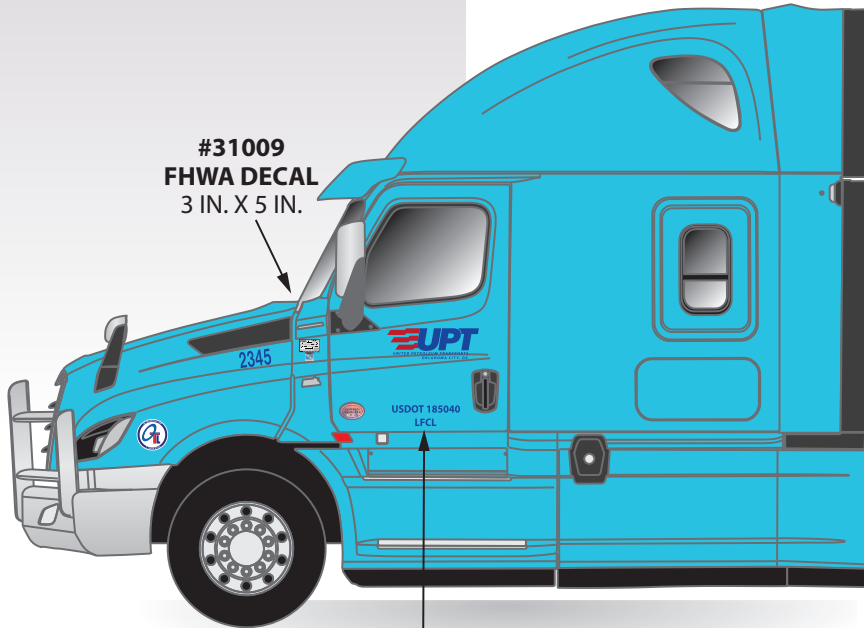

**#31009
FHWA DECAL**
3 IN. X 5 IN.

**#31102
LFCL (BLUE)**
2 IN. X 5.32 IN.
(X2)

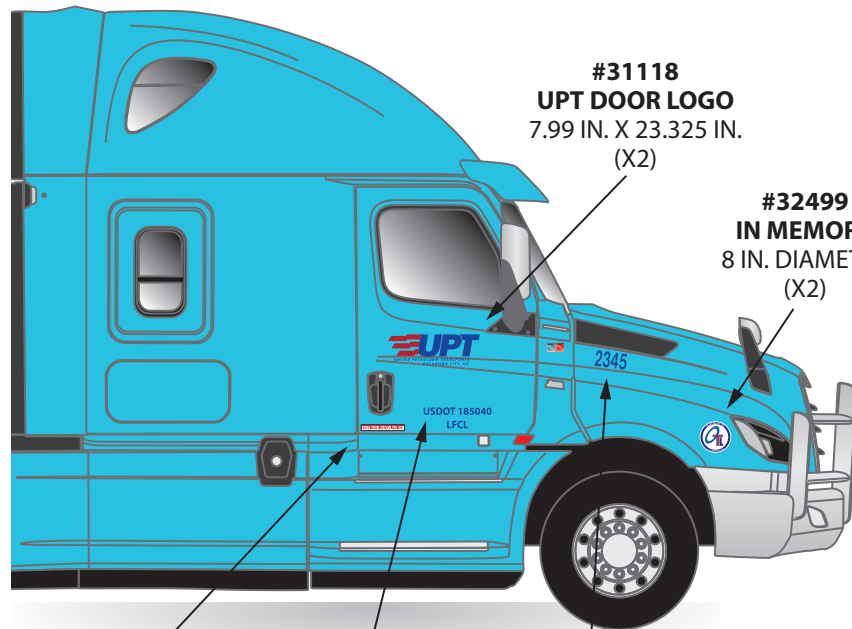
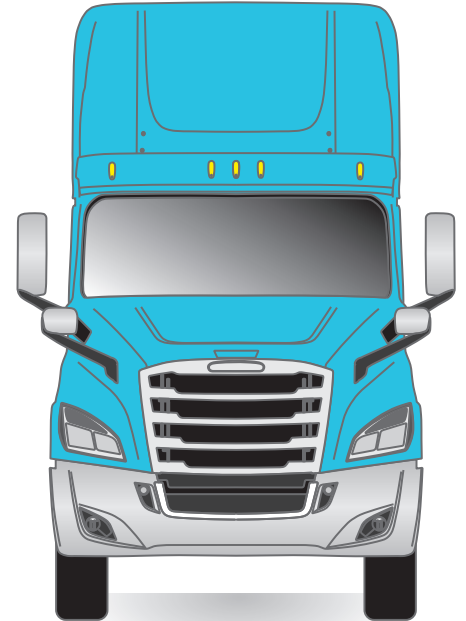

**#31118
UPT DOOR LOGO**
7.99 IN. X 23.325 IN.
(X2)

**#32499
IN MEMORY**
8 IN. DIAMETER
(X2)

**#31098
FIRE EXTIN.**
1.5 IN. X 11 IN.

**#31106
USDOT DECAL**
2 IN. X 17.258 IN.
(X2)

**#32111
4 IN. UNIT NUMBER**
4 INCH TALL
(X2)

2017-2025 MACK ANTHEM DAYCAB

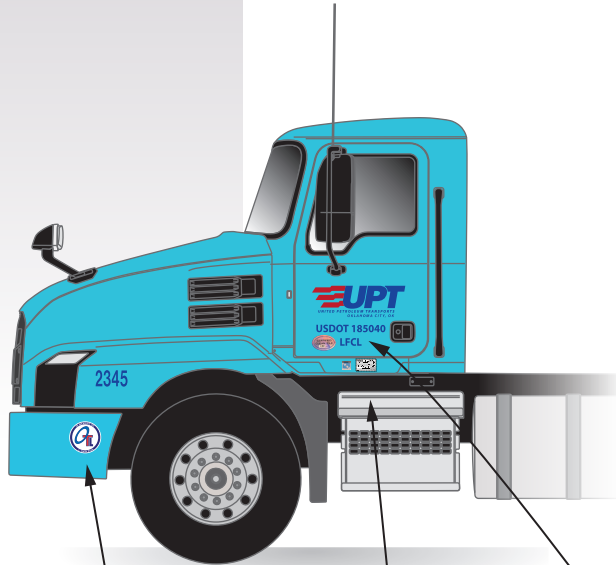

#32499
IN MEMORY
8 IN. DIAMETER
(X2)

#31009
FHWA DECAL
3 IN. X 5 IN.

#31102
LFCL (BLUE)
2 IN. X 5.32 IN.
(X2)

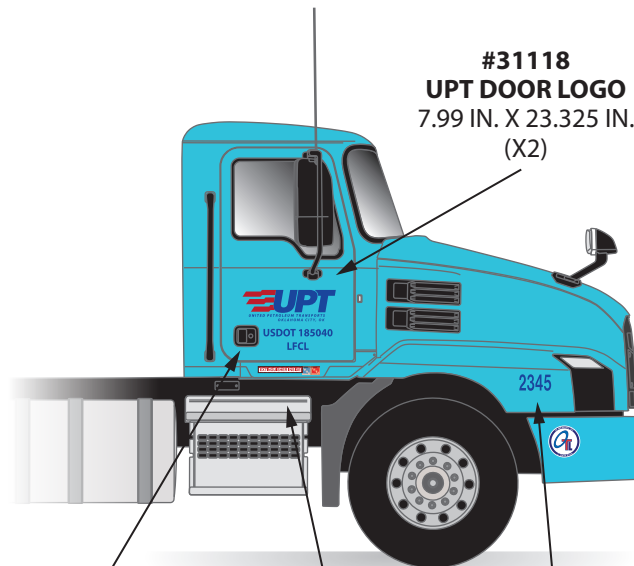

#31118
UPT DOOR LOGO
7.99 IN. X 23.325 IN.
(X2)

#31106
USDOT DECAL
2 IN. X 17.258 IN.
(X2)

#31098
FIRE EXTIN.
1.5 IN. X 11 IN.

#32111
4 IN. UNIT NUMBER
4 INCH TALL
(X2)

2017-2025 MACK ANTHEM SLEEPER

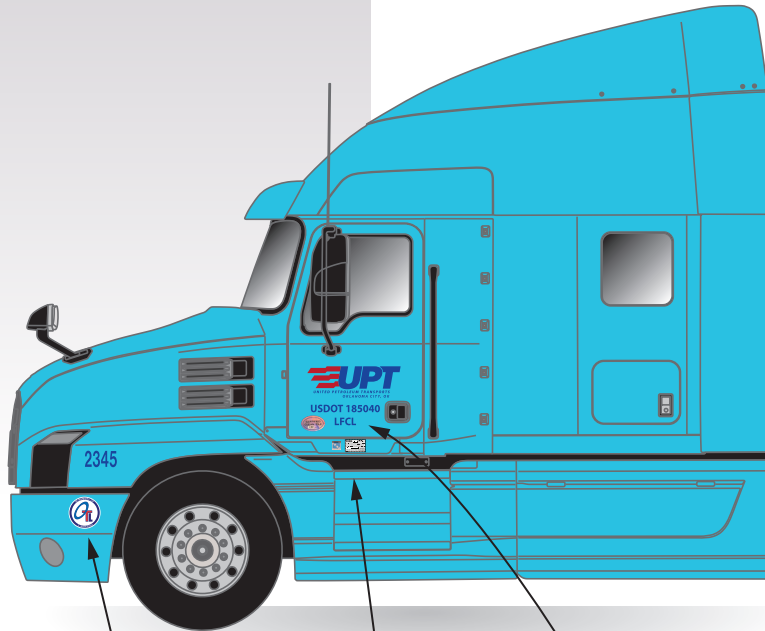

**#32499
IN MEMORY**
8 IN. DIAMETER
(X2)

**#31009
FHWA DECAL**
3 IN. X 5 IN.

**#31102
LFCL (BLUE)**
2 IN. X 5.32 IN.
(X2)

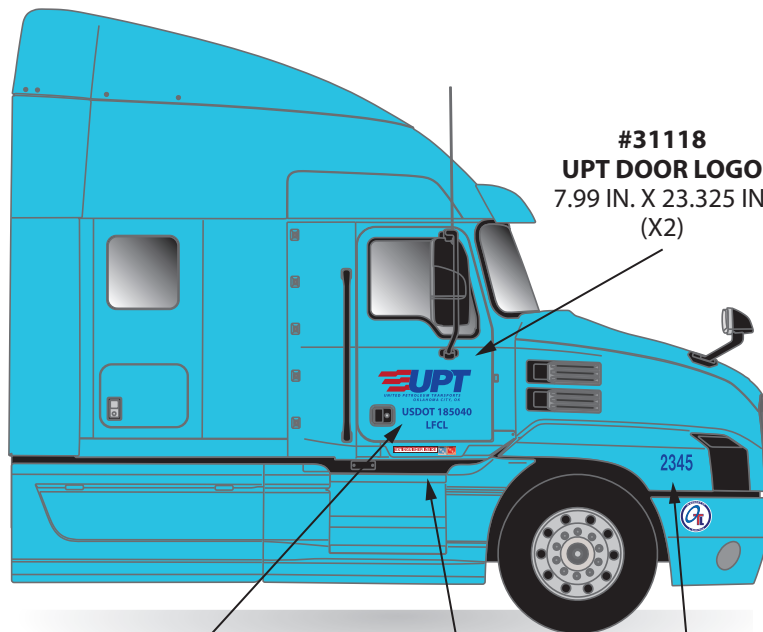
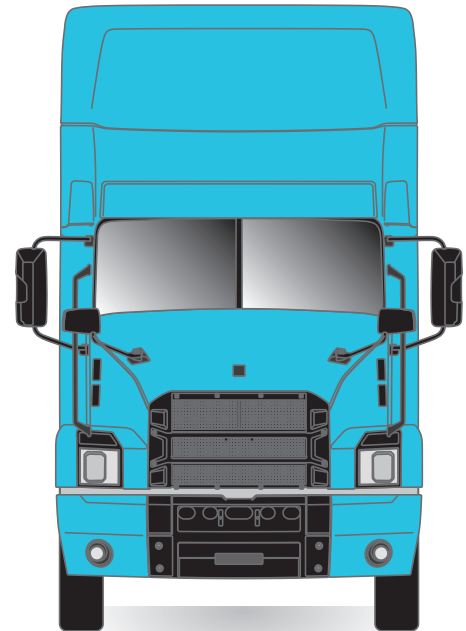







**#31118
UPT DOOR LOGO**
7.99 IN. X 23.325 IN.
(X2)

**#31106
USDOT DECAL**
2 IN. X 17.258 IN.
(X2)

**#31098
FIRE EXTIN.**
1.5 IN. X 11 IN.

**#32111
4 IN. UNIT NUMBER**
4 INCH TALL
(X2)

ITEM	DESCRIPTION	IMAGE	SIZE	QTY
30780	36 IN. LOGO		10.29 IN. X 36 IN.	
30781	48 IN. LOGO		13.73 IN. X 48 IN.	
30778	72 IN. LOGO		20.5 IN. X 72 IN.	
31118	UPT DOOR LOGO RED AND BLUE		7.99 IN. X 23.325 IN.	
32158	UPT DOOR LOGO RED AND WHITE		7.99 IN. X 23.325 IN.	
32499	MEMORIAL DECAL		8 IN. DIAMETER	
31106	USDOT 185040 BLUE	USDOT 185040	2 IN. X 17.258	
32157	USDOT 185040 WHITE	USDOT 185040	2 IN. X 17.258	
30779	SMALL JOIN THE FAMILY	Join the UPT Family 800-353-5606 drive4upt.com	10.5 IN. X 28 IN.	
30782	LARGE JOIN THE FAMILY	Join the UPT Family 800-353-5606 drive4upt.com	17.25 IN. X 48 IN.	
31109	RAILROAD CROSSING	THIS VEHICLE STOPS AT ALL RAILROAD CROSSINGS	3 IN. X 45 IN.	
31098	FIRE EXTINGUISHER INSIDE	FIRE EXTINGUISHER INSIDE	1.5 IN. X 11 IN.	
31105	EMERGENCY SHUT OFF	EMERGENCY SHUT OFF	3 IN. X 5 IN.	
31097	DIESEL FIRST	DIESEL FIRST	5.625 IN. X 5.625 IN.	
31096	HM TEST LOG		15 IN. X 11 IN.	

*Thank You
In Advance
For Your Order!*



CONTACT INFORMATION:

620-663-5939

800-237-2171

fax: 620-663-2764

email:

kathyc@graphicimpressions1.com

jeffw@graphicimpressions1.com

ORDERING SERVICES

PAGE 2 OF 2

ITEM	DESCRIPTION	IMAGE	SIZE	QTY
31095	NO SMOKING		5 IN. X 17 IN.	
31104	VAPOR TIGHTNESS		4 IN. X 5.5 IN.	
31100	VAPOR TIGHTNESS TRANSPARENT OVERLAY		4 IN. X 5.5 IN.	
31099	FHWA		3 IN. X 5 IN.	
31102	LFCL (BLUE)		2 IN. X 5.32 IN.	
31101	LFCL (WHITE)		2 IN. X 5.32 IN.	
32653	LFCL NUMBERS 0-9		1.927 IN. TALL	
30925	TEN STEP		12 IN. X 12 IN.	
32556	ABS		1.5 IN. X 3.5 IN.	
31108	BLACK 1.5 IN. UNIT NUMB.		1.5 IN. TALL	
32111	BLUE 4 IN UNIT NUMBER		4 IN. TALL	
32566	WHITE 4 IN UNIT NUMBER		4 IN. TALL	
32978	TRANSPARENT OVERLAY *COMPLIANCE ORDERS ONLY*	 4 MIL. CLEAR POLYESTER, SQUARE CUT, SCORE	4 IN. X 4 IN.	

Thank You
In Advance
For Your Order!



CONTACT INFORMATION:

620-663-5939

800-237-2171

fax: 620-663-2764

email:

kathyc@graphicimpressions1.com

jeffw@graphicimpressions1.com